

PART No: TWVB-D-20

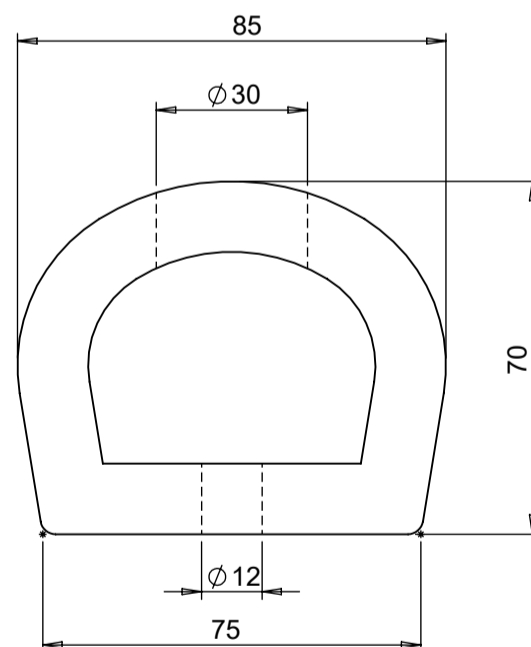

Thorworld Moulded Vehicle bumpers provide excellent support to vehicles, loading dock equipment and the loading docks they are visiting. Please Note: Vehicle Bumpers are not suitable for fitting to Loading Docks.

MATERIAL	Rubber
WEIGHT	4.5 Kg
ESTIMATED LEADTIME	1-2 Weeks
NO. HOLES	2

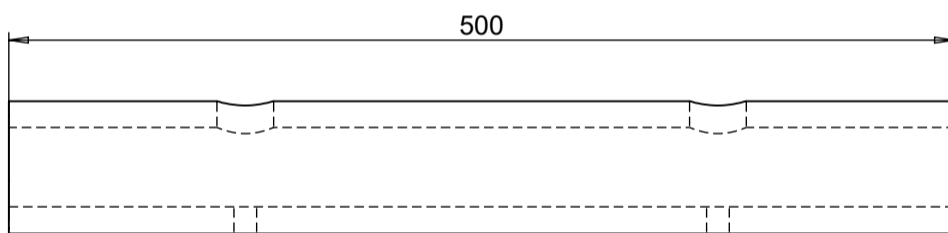
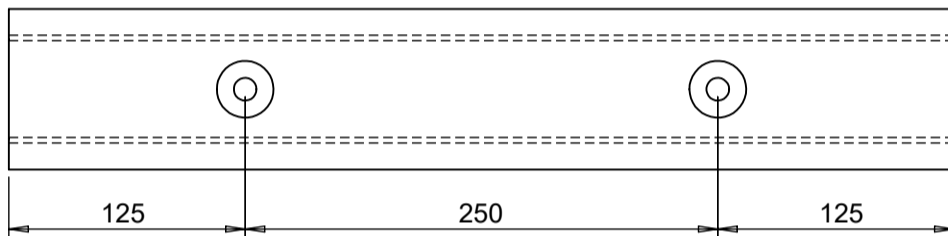

All dimensions shown are in millimetres and are intended for reference purposes only; exact product measurements may vary due to applied tolerances and methods of manufacture
SIZES MAY VARY FROM PREVIOUS DELIVERIES/ORDERS

